

THE RANGE OF PROBES FOR TOOL CHECKS ON MACHINING CENTRES

The TLS line represents a complete range of compact probes for tool checks on machining centres.

They may be used for the following checks:

- Tool breakage, in order to avoid damaging the workpieces and the machines, and the resulting production delays.
- Tool length
- Tool wear compensation, in order to optimise working life
- Determining tool offsets in order to reduce set-up times and eliminate the need to pre-set the tools before mounting them in the machine

TLS probes offer excellent repeatability at high touch speeds, which increases production quality and reduces cycle times significantly, and this means that they represent the ideal solution for mass production and unmonitored processing applications.

The IP67 protection class (IEC 60529) guarantees high performance even in hostile machining environments. The air cleaning system guarantees that the probes are not affected by shavings or coolant.

Main Characteristics

- Excellent repeatability
- Reduced cycle times
- Immunity to machine vibration
- Highly resistant to coolants
- High reliability

Tool length pre-setter

- For CNC controlled, vertical machining centres
- Tool wear/breakage check
- Thermal warping check

- Normally installed on a mobile horizontal table that moves the sensor into position and waits for the tool to touch the plate vertically.

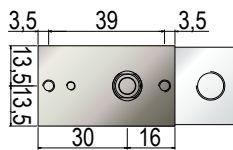
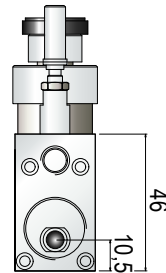
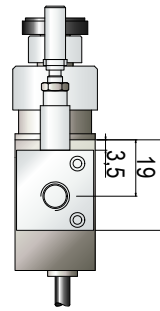
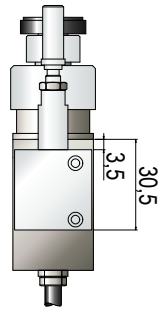
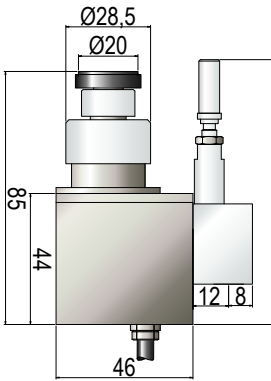
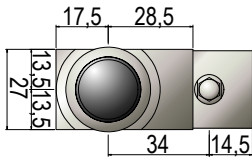

Q3PTLS11352

Q3PTLS11393

Q3PTLS11304
Q3PTLS11394

Q3PTLS11395

	Q3PTLS11352	Q3PTLS11393	Q3PTLS11304	Q3PTLS11394	Q3PTLS11395
CONTACTS	1	1	1	1	1
TOTAL STROKE	8 mm	8 mm	8 mm	8 mm	8 mm
CLEANING AIR	Yes	Yes	Yes	Yes	Yes
LED	No	No	No	No	No
BUILT-IN INTERFACE	No	Yes	No	Yes	Yes
CABLE OUTPUT <i>1 = lower / 2 = side</i>	1	1	1	1	2
CABLE DIAMETER	5 mm	5 mm	5 mm	5 mm	5 mm
CABLE LENGTH	10 m	10 m	10 m	10 m	10 m
CONTACT WORKING LIFE	3 × 10 ⁶ cycles	3 × 10 ⁶ cycles	3 × 10 ⁶ cycles	3 × 10 ⁶ cycles	3 × 10 ⁶ cycles
PROTECTION CLASS <i>(Standard IEC 60529)</i>	IP67	IP67	IP67	IP67	IP67
Skip signal					
STROKE	0.5 mm	0.5 mm	0.5 mm	0.5 mm	0.5 mm
REPEATABILITY (2σ)	1 μm	1 μm	1 μm	1 μm	1 μm
MEASUREMENT FORCE	1.2 ÷ 1.7 N	1.2 ÷ 1.7 N	1.2 ÷ 1.7 N	1.2 ÷ 1.7 N	1.2 ÷ 1.7 N
OPERATING MODE	Norm. closed (NC)	Norm. open (NO)	Norm. closed (NC)	Norm. open (NO)	Norm. open (NO)
TOUCH SPEED	50 ÷ 200 mm/min	50 ÷ 200 mm/min	50 ÷ 200 mm/min	50 ÷ 200 mm/min	50 ÷ 200 mm/min
POWER SUPPLY	24 Vdc - 20 mA max	24 Vdc - 20 mA max	24 Vdc - 20 mA max	24 Vdc - 20 mA max	24 Vdc - 20 mA max
Overtravel signal					
STROKE	5 mm	5 mm	5 mm	5 mm	5 mm
OPERATING MODE	NC	NC / NO	NC	NC / NO	NC / NO
POWER SUPPLY	24 Vdc - 20 mA max	24 Vdc - 20 mA max	24 Vdc - 20 mA max	24 Vdc - 20 mA max	24 Vdc - 20 mA max

Tool length pre-setter

- For CNC controlled, vertical machining centres
- Tool wear/breakage check
- Thermal warping check
- Normally installed on a mobile horizontal table that moves the sensor into position and waits for the tool to touch the plate vertically.

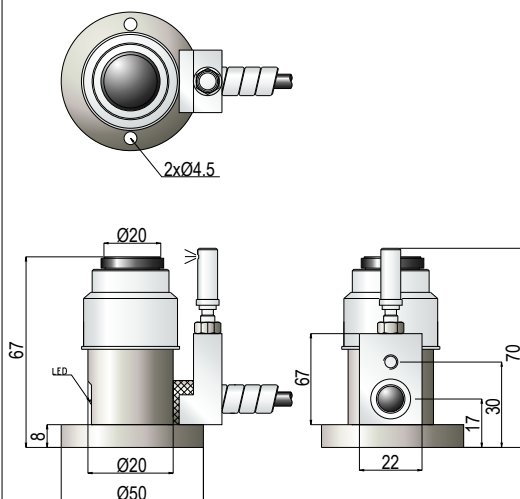

Q3PTLS10312



CONTACTS	1
TOTAL STROKE	5 mm
CLEANING AIR	Yes
LED	Yes
BUILT-IN INTERFACE	Yes
CABLE OUTPUT <i>1 = lower / 2 = side</i>	2
CABLE DIAMETER	5 mm
CABLE LENGTH	5 m
CONTACT WORKING LIFE	3×10^6 cycles
PROTECTION CLASS <i>(Standard IEC 60529)</i>	IP67

Skip signal

STROKE	0.5 mm
REPEATABILITY (2σ)	1 μ m
MEASUREMENT FORCE	2.5 ÷ 3 N
OPERATING MODE	Norm. closed (NC)
TOUCH SPEED	50 ÷ 200 mm/min
POWER SUPPLY	24 Vdc - 20 mA max

Overtravel signal

STROKE	3 mm
OPERATING MODE	NC
POWER SUPPLY	24 Vdc - 20 mA max

Tool length pre-setter

- For CNC controlled, vertical machining centres
- Tool wear/breakage check
- Thermal warping check
- Normally installed on a mobile horizontal table that moves the sensor into position and waits for the tool to touch the plate vertically.

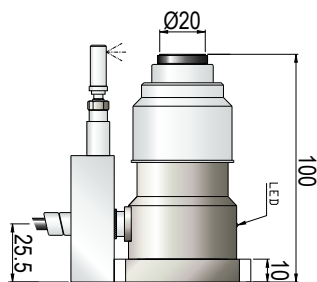
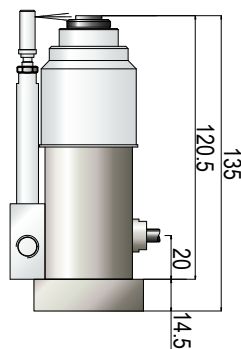
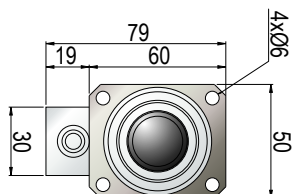
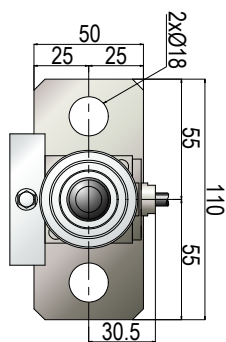

Q3PTLS10290

Q3PTLS10382



	Q3PTLS10290	Q3PTLS10382
CONTACTS	1	1
TOTAL STROKE	26 mm	12 mm
CLEANING AIR	Yes	Yes
LED	No	Yes
BUILT-IN INTERFACE	Yes	Yes
CABLE OUTPUT <i>1 = lower / 2 = side</i>	2	2
CABLE DIAMETER	5 mm	5 mm
CABLE LENGTH	10 m	7 m
CONTACT WORKING LIFE	3×10^6 cycles	3×10^6 cycles
PROTECTION CLASS <i>(Standard IEC 60529)</i>	IP67	IP67

Skip signal

STROKE	0.5 mm	0.5 mm
REPEATABILITY (2σ)	1 μ m	1 μ m
MEASUREMENT FORCE	2.5÷3	2.5÷3
OPERATING MODE	Norm. open (NO)	Norm. open (NO)
TOUCH SPEED	50÷200 mm/min	50÷200 mm/min
POWER SUPPLY	24 Vdc - 20 mA max	24 Vdc - 20 mA max

Overtravel signal

STROKE	10.5 mm	6 mm
OPERATING MODE	NC / NO	NC
POWER SUPPLY	24 Vdc - 20 mA max	24 Vdc - 20 mA max

Precision tool position detector

- For CNC controlled machining centres
- Tool wear/breakage check
- Thermal warping check
- Repeatability 0.5 μm
- Large plate surface area for compatibility with wide range of tool sizes.
- Particularly suitable for detecting tool breakages (end mills)
- Compact size for use in restricted spaces and various configurations
- Normally installed on mobile horizontal/vertical tables that move the sensor into position and wait for the tool to touch the plate vertically.

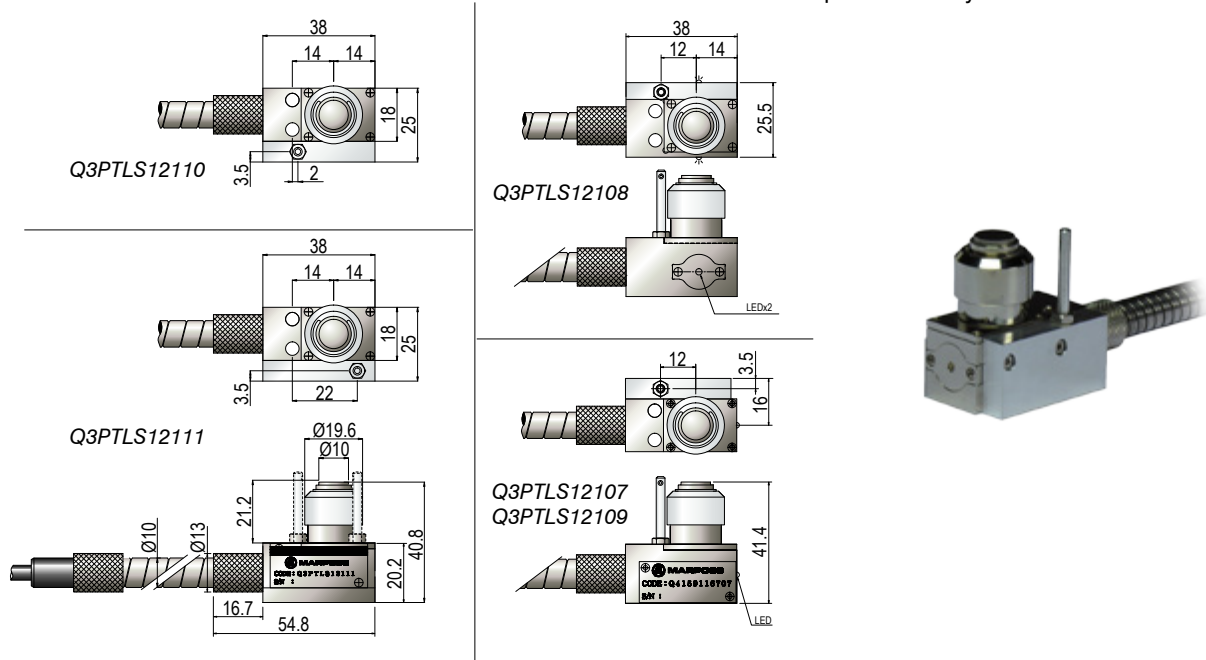

	Q3PTLS12107	Q3PTLS12109	Q3PTLS12110	Q3PTLS12111	Q3PTLS12108
CONTACTS	1	1	1	1	1
TOTAL STROKE	5 mm	5 mm	5 mm	5 mm	5 mm
CLEANING AIR	Yes	Yes	Yes	Yes	Yes
LED	Yes	Yes	Yes	Yes	Yes
BUILT-IN INTERFACE	No	No	No	No	No
CABLE OUTPUT <i>1 = lower / 2 = side</i>	2	2	2	2	2
CABLE DIAMETER	5 mm	5 mm	5 mm	5 mm	5 mm
CABLE LENGTH	3 m	3 m	3 m	3 m	3 m
CONTACT WORKING LIFE	3×10^6 cycles	3×10^6 cycles	3×10^6 cycles	3×10^6 cycles	3×10^6 cycles
PROTECTION CLASS <i>(Standard IEC 60529)</i>	IP67	IP67	IP67	IP67	IP67
Skip signal					
STROKE	≈ 0	≈ 0	≈ 0	≈ 0	≈ 0
REPEATABILITY (2σ)	0.5 μm	0.5 μm	0.5 μm	0.5 μm	0.5 μm
MEASUREMENT FORCE	1.5 \div 2 N	0.5 N	0.5 N	0.5 N	0.5 N
OPERATING MODE	Norm. closed (NC)	Norm. closed (NC)	Norm. closed (NC)	Norm. closed (NC)	Norm. closed (NC)
TOUCH SPEED	50 \div 200 mm/min	50 \div 200 mm/min	50 \div 200 mm/min	50 \div 200 mm/min	50 \div 200 mm/min
POWER SUPPLY	24 Vdc - 20 mA max	24 Vdc - 20 mA max	24 Vdc - 20 mA max	24 Vdc - 20 mA max	24 Vdc - 20 mA max
Overtravel signal					
STROKE	3 mm	3 mm	3 mm	3 mm	3 mm
OPERATING MODE	NC	NC	NC	NC	NC
POWER SUPPLY	24 Vdc - 20 mA max	24 Vdc - 20 mA max	24 Vdc - 20 mA max	24 Vdc - 20 mA max	24 Vdc - 20 mA max

Precision tool position detector

- For small scale, CNC controlled machining centres
- Tool wear/breakage check
- Thermal warping check
- Reduced size (plate type) guarantees excellent parallelism between the plate and contact surfaces.
- Particularly suitable for small scale machining centres thanks to the small size of the plate
- Compact size for use in restricted spaces and various configurations
- Normally installed on mobile horizontal/vertical tables that move the sensor into position and wait for the tool to touch the plate vertically.

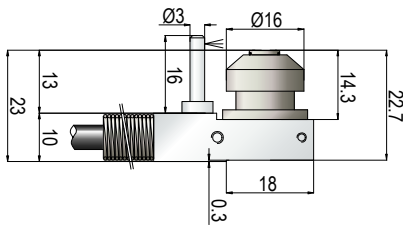
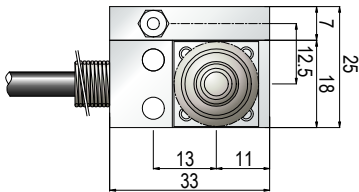

Q3PTLS12094



CONTACTS	1
TOTAL STROKE	3 mm
CLEANING AIR	Yes
LED	No
BUILT-IN INTERFACE	No
CABLE OUTPUT	2
<i>1 = lower / 2 = side</i>	
CABLE DIAMETER	5 mm
CABLE LENGTH	3 m
CONTACT WORKING LIFE	3×10^6 cycles
PROTECTION CLASS <i>(Standard IEC 60529)</i>	IP67





Skip signal

STROKE	≈0
REPEATABILITY (2σ)	1 μm
MEASUREMENT FORCE	1.5 ÷ 2 N
OPERATING MODE	Norm. closed (NC)
TOUCH SPEED	50 ÷ 200 mm/min
POWER SUPPLY	24 Vdc - 20 mA max

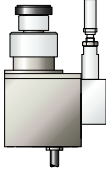
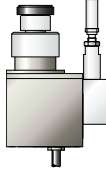

Overtravel signal

STROKE	/
OPERATING MODE	/
POWER SUPPLY	/

Summary table

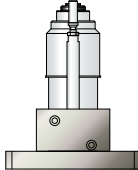
	Q3PTLS11352	Q3PTLS11393	Q3PTLS11304	Q3PTLS11394	Q3PTLS11395
PROBE TYPE					
CONTACTS	1	1	1	1	1
TOTAL STROKE	8 mm	8 mm	8 mm	8 mm	8 mm
CLEANING AIR	Yes	Yes	Yes	Yes	Yes
LED	No	No	No	No	No
BUILT-IN INTERFACE	No	Yes	No	Yes	Yes
CABLE OUTPUT <i>1 = lower / 2 = side</i>	1	1	1	1	2
CABLE DIAMETER	5 mm	5 mm	5 mm	5 mm	5 mm
CABLE LENGTH	10 m	10 m	10 m	10 m	10 m
CONTACT WORKING LIFE	3×10^6 cycles	3×10^6 cycles	3×10^6 cycles	3×10^6 cycles	3×10^6 cycles
PROTECTION CLASS <i>(Standard IEC 60529)</i>	IP67	IP67	IP67	IP67	IP67
Skip signal					
STROKE	0.5 mm	0.5 mm	0.5 mm	0.5 mm	0.5 mm
REPEATABILITY (2σ)	1 μ m	1 μ m	1 μ m	1 μ m	1 μ m
MEASUREMENT FORCE	1.2÷1.7 N	1.2÷1.7 N	1.2÷1.7 N	1.2÷1.7 N	1.2÷1.7 N
OPERATING MODE	Norm. closed (NC)	Norm. open (NO)	Norm. closed (NC)	Norm. open (NO)	Norm. open (NO)
TOUCH SPEED	50÷200 mm/min	50÷200 mm/min	50÷200 mm/min	50÷200 mm/min	50÷200 mm/min
POWER SUPPLY	24 Vdc - 20 mA max	24 Vdc - 20 mA max	24 Vdc - 20 mA max	24 Vdc - 20 mA max	24 Vdc - 20 mA max
Overtravel signal					
STROKE	5 mm	5 mm	5 mm	5 mm	5 mm
OPERATING MODE	NC	NC / NO	NC	NC / NO	NC / NO
POWER SUPPLY	24 Vdc - 20 mA max	24 Vdc - 20 mA max	24 Vdc - 20 mA max	24 Vdc - 20 mA max	24 Vdc - 20 mA max

	Q3PTLS10312	Q3PTLS10290	Q3PTLS10382	Q3PTLS12107	Q3PTLS12109
PROBE TYPE					
CONTACTS	1	1	1	1	1
TOTAL STROKE	5 mm	26 mm	12 mm	5 mm	5 mm
CLEANING AIR	Yes	Yes	Yes	Yes	Yes
LED	Yes	No	Yes	Yes	Yes
BUILT-IN INTERFACE	Yes	Yes	Yes	No	No
CABLE OUTPUT <i>1 = lower / 2 = side</i>	2	2	2	2	2
CABLE DIAMETER	5 mm	5 mm	5 mm	5 mm	5 mm
CABLE LENGTH	5 m	10 m	7 m	3 m	3 m
CONTACT WORKING LIFE	3×10^6 cycles	3×10^6 cycles	3×10^6 cycles	3×10^6 cycles	3×10^6 cycles
PROTECTION CLASS <i>(Standard IEC 60529)</i>	IP67	IP67	IP67	IP67	IP67
Skip signal					
STROKE	0.5 mm	0.5 mm	0.5 mm	≈0	≈0
REPEATABILITY (2σ)	1 μ m	1 μ m	1 μ m	0.5 μ m	0.5 μ m
MEASUREMENT FORCE	2.5÷3 N	2.5÷3	2.5÷3	1.5÷2 N	0.5 N
OPERATING MODE	Norm. closed (NC)	Norm. open (NO)	Norm. open (NO)	Norm. closed (NC)	Norm. closed (NC)
TOUCH SPEED	50÷200 mm/min	50÷200 mm/min	50÷200 mm/min	50÷200 mm/min	50÷200 mm/min
POWER SUPPLY	24 Vdc - 20 mA max	24 Vdc - 20 mA max	24 Vdc - 20 mA max	24 Vdc - 20 mA max	24 Vdc - 20 mA max
Overtravel signal					
STROKE	3 mm	10.5 mm	6 mm	3 mm	3 mm
OPERATING MODE	NC	NC / NO	NC	NC	NC
POWER SUPPLY	24 Vdc - 20 mA max	24 Vdc - 20 mA max	24 Vdc - 20 mA max	24 Vdc - 20 mA max	24 Vdc - 20 mA max

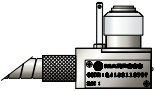
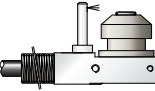
	Q3PTLS12110	Q3PTLS12111	Q3PTLS12108	Q3PTLS12094	
PROBE TYPE					
CONTACTS	1	1	1	1	
TOTAL STROKE	5 mm	5 mm	5 mm	3 mm	
CLEANING AIR	Yes	Yes	Yes	Yes	
LED	Yes	Yes	Yes	No	
BUILT-IN INTERFACE	No	No	No	No	
CABLE OUTPUT <i>1 = lower / 2 = side</i>	2	2	2	2	
CABLE DIAMETER	5 mm	5 mm	5 mm	5 mm	
CABLE LENGTH	3 m	3 m	3 m	3 m	
CONTACT WORKING LIFE	3 × 10 ⁶ cycles	3 × 10 ⁶ cycles	3 × 10 ⁶ cycles	3 × 10 ⁶ cycles	
PROTECTION CLASS <i>(Standard IEC 60529)</i>	IP67	IP67	IP67	IP67	
Skip signal					
STROKE	≈0	≈0	≈0	≈0	
REPEATABILITY (2σ)	0.5 μm	0.5 μm	0.5 μm	1 μm	
MEASUREMENT FORCE	0.5 N	0.5 N	0.5 N	1.5÷2 N	
OPERATING MODE	Norm. closed (NC)	Norm. closed (NC)	Norm. closed (NC)	Norm. closed (NC)	
TOUCH SPEED	50÷200 mm/min	50÷200 mm/min	50÷200 mm/min	50÷200 mm/min	
POWER SUPPLY	24 Vdc - 20 mA max	24 Vdc - 20 mA max	24 Vdc - 20 mA max	24 Vdc - 20 mA max	
Overtravel signal					
STROKE	3 mm	3 mm	3 mm	/	
OPERATING MODE	NC	NC	NC	/	
POWER SUPPLY	24 Vdc - 20 mA max	24 Vdc - 20 mA max	24 Vdc - 20 mA max	/	



www.marposs.com

For a full list of address locations, please consult the Marposs official website

D6C07200G0 - Edition 08/2014 - Specifications are subject to modifications
© Copyright 2011-2014 MARPOSS S.p.A. (Italy) - All rights reserved.

MARPOSS, ® and Marposs product names/signs mentioned or shown herein are registered trademarks or trademarks of Marposs in the United States and other countries. The rights, if any, of third parties on trademarks or registered trademarks mentioned in the present publication are acknowledged to the respective owners.

Marposs has an integrated system to manage the Company quality, the environment and safety, attested by ISO 9001, ISO 14001 and OHSAS 18001 certifications. Marposs has further been qualified EAQF 94 and has obtained the Q1-Award.



Download the latest version of this document